

AVK SOUTHERN AFRICA WATER SUPPLY



YOUR WATER
SOLUTIONS PROVIDER

Expect... **AVR**



WHO WE ARE



The AVK Group is a privately owned group that comprises of more than 80 companies across the world with headquarters based in Denmark. AVK Valves Southern Africa (AVK-SA), was established in Pretoria, in 1991. After acquiring a major stake in the Premier Valves Group, AVK SA relocated to Alrode, Gauteng. As AVK Holding Southern Africa, the Premier range of products continues to be marketed by Premier Valves under its own brand and AVK branded products by AVK Valves Southern Africa.

AVK's offices and factory was built on the existing Premier Valves premises in Alrode in 2014. The expanded premises covers a profound area of 46 000 m², which includes a 1 200 m² training facility, a 2 500 m² office area and a 2 000 m² distribution centre. The two companies have worked closely together since the merger to expand and strengthen the overall position of AVK Holding Southern Africa by focusing on valves and accessories for water distribution, water treatment, waste water handling, dams, reservoirs, pump stations and fire protection.

Together, AVK and Premier Valves have over 60 years of experience in design, development

and the production of valves and have an established distribution network that services all Water Sectors in Southern Africa. All products offered by AVK and Premier Valves meet the relevant international quality and design standards.

Furthermore, all products are supported by experienced sales and service teams to ensure the best possible before-and-after sales service. All appointed distributors receive full technical training and support from AVK and Premier Valves.

In December 2016, AVK Holding Southern Africa made a significant investment by

purchasing the intellectual property (IP) and all brand assets of Gunric Valves. This strategic move has increased AVK's product range to include the innovative triple eccentric butterfly valve and tilting disc check valve. Gunric products will continue to be manufactured at the existing factory facility in Robertville, Florida. Investing in Gunric has not only increased AVK's local manufacturing footprint but deepened the product programme offering to customers.



MEMBERS OF THE AVK GROUP

The AVK Group manufactures a diverse range of standardised, specialised and customised engineered valve products. AVK together with its members; Premier Valves, Gunric Valves, Wouter Witzel, Orbinox, Interapp and Glenfield, aim to be the preferred valve supplier to the water industry.



**PREMIER
VALVES**

THE PREMIER VALVES GROUP

Premier Valves is a proud member of the AVK Group. Cementation Engineering, PVE, IPV and Baker Control are product brands that strive for excellence by working together in the Premier Valves Group.

For more information visit www.premiervalves.com



GUNRIC VALVES

In December 2016, AVK Holding Southern Africa made a strategic investment by purchasing the brand assets and intellectual property of Gunric Valves.

Gunric has always specialised in manufacturing and exporting large diameter and made-to-order Butterfly Valves and Tilting Disc Check Valves. Gunric will continue to operate at the existing facility in Robertville, Florida, Johannesburg.



Members of the



WOUTER WITZEL

Wouter Witzel is located in the Netherlands, and designs and produces butterfly valves for complex and automated industrial processes. With the rubber lined valve type as basic model, a great variety of valves can be offered with different materials in valve bodies, discs and seals. The international recognition has been gained from fifty years of manufacturing and product developments.



ORBINOX

Orbinox with headquarters in Spain has 45 years of experience in designing, manufacturing knife gate valves, penstocks, dampers and valves for hydraulic works. The Products are often engineered to the customer's requirement both in dimensions and manufactured in different materials. Products are installed and used in more than 70 countries.

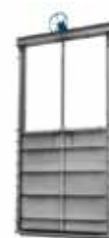

INTER APP

Inter App with headquarters in Switzerland has more than 40 years of experience with designing and manufacturing special valves of high quality with focus on high performance valves for selected industries.



GLENFIELD

Glenfield Valves Limited have been part of the AVK Group for many years. They pride themselves in being one of the leading valve manufacturers of large bore valves for the water industry for waterworks, transmission lines, dams and reservoirs.





























DISCOVER OUR PRODUCT RANGE

OUR PRODUCT RANGE: WATER SUPPLY

WATER SUPPLY

Distribution | Transmission | Plant Work

						
1 High Performance Butterfly Valves						
2 Centric butterfly valves with loose or fixed liner						
3 Double eccentric butterfly valves						
4 Penstocks wall mounted or channel mounted						
5 Control valves						
6 Check valves						
7 Gate valves						

















WASTE WATER TREATMENT

Collection | Treatment | Outlet

						
1 High Performance Butterfly Valves						
2 Knife Gate Valves						
3 Gate Valves						
4 Butterfly Valves						
5 Ball Check Valves & Plug Valves						
6 Penstock						





























PUMP STATIONS

Outdoor | Indoor

					
1 Gate Valves					
2 Non-Return Valves					
3 Butterfly Valves					
4 Air Release Valves					
5 Pump Start-up control					









DAMS, RESERVOIRS AND HYDROPOWER

Transmission | Controls

						
1 High performance butterfly valves						
2 Centric butterfly valves with loose or fixed liner						
3 Double eccentric butterfly valves						
4 Sleeves and Special control valves						
5 Penstocks wall mounted or channel mounted						
6 Gate valves						
7 Check valves						

FIRE PROTECTION

Outdoor | Indoor

					
1 Gate Valves					
2 Hydrants					
3 Butterfly Valves					
4 Fire Hydrants					



WATER SUPPLY

GATE VALVES



Premier Wedge Gate Valve

Metal seated solid wedge rising and NRS designs with channel guides and shoes to BS 5163, DIN and SABS specs.

Specifics:

Sizes: 50mm to 2000mm

Pressure: 10 - 64bar

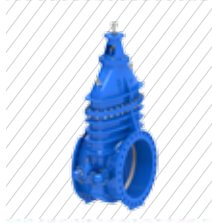

Series 54 Gate Valves

Aluminium Bronze Trim
Epoxy Coated (250 microns)
Stem Seal Gland Packing
PTFE
ISO Mounting Flange
Lifting Eyes
Stainless Steel Stem
Gearbox
WRAS Approved

Specifics:

Size:
DN350-1800

Temperature: 0-70°C



Series 06/30 RSV Flanged gate valve PN10/16

Designed according to BS5150 / DN 3202 Part 1; Non-Rising Spindle; Standard Flange drilling ISO 7005-2; RHC and LHC; Face to Face to BS 5150/en10741&2; Epoxy coated according to DIN 30677-2 and GSK Guidelines; Closing direction: RHC & LHC.

Specifics:

Size:
DN50 - DN800

Temperature:
0 to +70°C



Series 55/30 RSV Flanged gate valves PN10/16 (450mm - 600mm)

Designed according to DIN / EN; Face to Face according to EN 558 TABLE 2 BASIC SERIES 15; Standard flange drilling to EN1081-2; GSK guidelines; Hydraulic test according to EN 1074-1.

Specifics:

SIZE:
DN450 - DN600

Temperature:
0 to +70°C



Series 34 Wedge Gate Valves

Aluminium Bronze Trim
O-Ring Stem Seal
Repack Under Pressure
Cap Top
Epoxy Coated (250 microns)
Stainless steel Stem

WRAS Approved

Specifics:

Size:
DN50-300
Flanges to BS EN 1092-2
PN18

Temperature: 0-70°C



Series 02/60 RSV Flanged gate valve PN10/16

Designed according to EN1074 part 1 & 2 and EN1171; Face to Face according to EN 558 Table 2 Basic Series 15; Standard flange drilling to EN1092 (ISO 7005-5); Hydraulic test according to EN 1074-1 and 2/EN 12266; Epoxy coating to DIN 30677-2 and AVK Guidelines. Closing direction: RHC and LHC. (for drinking water and neutral liquids to max 70°C).

Specifics:

Size:
DN400 - DN500

Temperature:
0 to +70°C



Series 02/20 RSV Flanged gate valve PN10/16

Designed according to EN1074 part 1 & 2 and EN1171; Face to Face according to EN 558 Table 2; Basic Series 3; Standard flange drilling to EN1092 (ISO 7005-5); Hydraulic test according to EN 1074 and 2/ EN 12266; Epoxy coating to DIN 30677-2; GSK approved. (for drinking water and neutral liquids to max 70°C).

Specifics:

Size:
DN50 - DN400

Temperature:
0 to +70°C



Series 21/60 RSV Flanged gate valve PN25

Designed according to BS5163 & EN1074 Part 1 & 2; Standard Flange drilling len1092-2 (ISO 7005-2); Face to Face to EN558 Table 2 basic series 3; Closing direction: RHC & LHC; Stem Sealing exchangeable under pressure.

Specifics:

Size:
DN50 - DN400

Temperature:
0 to +70°C



Series 21/66 RSV gate valve with rising stem and handwheel PN25

Designed according to EN 1074 part 1 & 2; Flange drilling to EN 1092-2 (ISO 7005-2); Face to Face according to EN 558 table 2 basic series 3; Hydraulic test according to EN1074-2 (for water, sewage and neutral liquids to max 70°C).

Specifics:

Size:
DN50 - DN400

Temperature:
0 to +70°C



Series 21/89 RSV gate valve with rising stem and handwheel PN16

Designed according to EN 1074 part 1 & 2; Flange drilling to EN 1092-2 (ISO 7005-2); Face to Face according to EN 558 table 2 basic series 3 (for water, sewage and neutral liquids to max 70°C).

Specifics:

Size:
DN50 - DN400

Temperature:
0 to +70°C



Series 06/35
RSV Flanged gate valves with PIN indicator and handwheel PN10/16

Designed according to EN1074 part 1 & 2 and EN1171; Face to Face according to EN 558 Table 2 Basic Series 14; Standard flange drilling to EN1092 (ISO 7005-5); Hydraulic test according to EN 1074-1 and 2/EN 12266; Epoxy coating to DIN 30677-2 and AVK Guidelines. Closing direction: RHC (for fire protection applications to Max of 70°C).

Specifics:

Size:
DN50 - DN300

Temperature:
0 to +70°C



Series 43/60
RSV Flanged gate valve PN10/16

Designed according to EN1074 part 1 & 2 and EN1171; Face to Face according to SABS 664/1989.A; Standard flange drilling to EN1092 (ISO 7005-5); Hydraulic test according to SABS 664; Non-Rising Spindle; Epoxy coating to DIN 30677-2 and AVK Guidelines. Available in RHC and LHC. (for drinking water and neutral liquids to max 70°C).

Specifics:

Size:
DN50 - DN300

Temperature:
0 to +70°C



Series 02/67
RSV Flanged gate valve PN25

Designed according to EN1074 part 1 & 2 and EN1171; Face to Face according to EN 558 Table 2 Basic Series 15; Standard flange drilling to EN1092 (ISO 7005-5); Hydraulic test according to EN 1074-1 and 2 / EN 12266; Epoxy coating to DIN 30677-2 and AVK Guidelines. (for drinking water and neutral liquids to max 70°C).

Specifics:

Size:
DN50 - DN300

Temperature:
0 to +70°C



Fast
Check Valve

Axial displacement valve that has a very fast close between 0.01 and 0.05 seconds. One piece circular disc valve with hydrodynamic profile running in flow direction allows the valve to operate in horizontal, vertical or inclined position.

Specifics:

Size:
DN 50 - 1200

Pressure: PN10 - PN40



Series 01/80
Socket ended RSV gate valve PN16

Designed according to EN 1074 part 1 & 2 and EN 1171; Hydraulic test according to EN 1074-1 & 2 / EN 12266; Epoxy coating to DIN 30677-2; GSK Approved; EURO socket ends, NRS. (for drinking water and neutral liquids to max 70°C).

Specifics:

Size:
DN50 - DN400

Temperature:
0 to +70°C



Premier Metal Seated Wedge Gate Valves

16bar and 25bar, handwheel, cap top, in non-rising stem. Unrestricted full bore.

Specifics:

Sizes: Up to 300mm

Pressure: 16bar, 25bar



Series 37/50
Metal seated gate valve PN10/16

Designed according to EN 1074 part 1 & 2; Flange drilling to EN 1092-2 (ISO 7005-2); Face to Face to EN558-1 series 3; Epoxy Coated according to DIN 30677-2 and GSK approved. (for water, sewage and neutral liquids to max 70°C).

Specifics:

Size:
DN50 - DN300

Temperature:
0 to +70°C



Series 32/89 (SABS 664)
Victaulic rising gate spindle valve PN16

Designed according to SABS 664 Specification; Rising spindle; Epoxy Coated Internally and Externally to DIN 30677-2.

Specifics:

Size:
DN50 - DN300

Temperature:
0 to +70°C



Series 32/89 (SABS 665)
Victaulic rising gate spindle valve PN16

Designed according to SABS 664 Specification; Rising spindle; Epoxy Coated Internally and Externally to DIN 30677-2.

Specifics:

DN50 - DN300

Temperature:
0 to +70°C



Series 32/82
Plain ended gate valve PN16

Designed according to SABS 664/1989; WITH SPIGOT ENDS FOR ASBESTOS CEMENT PIPES; Epoxy Coated Internally and Externally to DIN 30677; Closing available in RHC & LHC.

Specifics:

Size:
DN50 - DN300

Temperature:
0 to +70°C

WATER SUPPLY

GATE VALVES



Series 37/80
Metal Seated Gate
Valve PN25

Designed according to EN 1074 part 1 & 2; Flange drilling to SANS 1123; Face to Face to SANS 664-1 / EN558 Table 2 series 19; Available in RHC and LHC (for water, sewage and neutral liquids to max 70°C).

Specifics:

Size:
DN50 - DN300

Temperature:
0 to +70°C

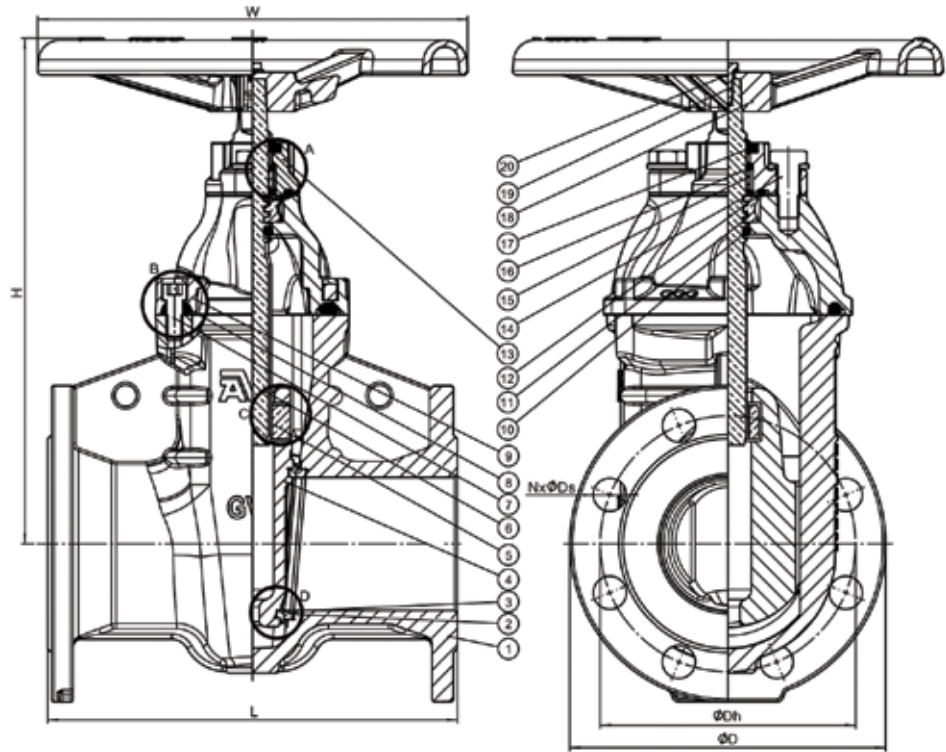

COMPONENT LIST

- | | |
|---------------------|----------------------|
| 1. Body | 11. Thrust collar |
| 2. Seat ring | 12. O-ring |
| 3. Face ring | 13. Gland |
| 4. Wedge | 14. Socket head bolt |
| 5. Wedge nut | 15. Bushing |
| 6. Stem | 16. O-ring |
| 7. Socket head bolt | 17. Wiper ring |
| 8. Bonnet gasket | 18. Handwheel |
| 9. Bonnet | 19. Bolt |
| 10. O-ring | 20. Washer |



AVK Series 37/80 Metal Seated Gate Valve with Handwheel, PN25

WATER SUPPLY

BUTTERFLY VALVES



Premier Boving type Flanged Butterfly Valve

This valve has been favoured by the waterworks industry for many years and is still very popular today. Standard design is double offset with resilient seal on the disc and replaceable St. St body seat. The valve is generally double flanged and manufactured to BS and ISO standards.

Specifics:

Sizes: 200mm to 3000mm

Pressure: 16bar & 25bar



Gunric Triple Eccentric Metal Seated Butterfly Valve Series 6145

Bubble Tight Shut, Fire Safe Certified Design, High Cycle, High Performance, Large Diameters, ISO 5211 Mount. Available in steel, ductile iron, stainless steel, nickel alloys, fabricated and castings.

Specifics:

Sizes: 80mm to 2500mm

Temperature: -35°C to +1000°C



Varix Cartridge type Rubberlined Butterfly Valve

Wafer, lugged and U-shaped flanged patterns are available with ductile iron nickel plated, or 316 St. St Disc. Standard liner is EPDM – available with Nitrile, Buna N, Viton and PTFE liners. The valve is available with either pinned shaft or square shaft to ensure a better connection between disc and shaft. The EPDM (or other) liner is moulded onto a phenolic cartridge which provides the unique feature of an easily replaceable bonded liner.

Specifics:

Sizes: 50mm to 1200mm

Pressure: 16 bar & 25 bar



Lugged Pattern Butterfly Valve

Lugged pattern available with replaceable bonded liner similar to wafer pattern.

Specifics:

Sizes: 50mm to 600mm

Pressure: 16bar & 25bar



Varix U-Pattern Butterfly Valve

Varix U-Pattern available with replaceable bonded liner similar to wafer pattern.

Specifics:

Sizes: 150mm to 1200mm

Pressure: 10bar 16bar



Premier Double Flanged Rubberlined Butterfly Valve

Concentric Disc Butterfly Valve with bonded rubber liner. Available with:

- D.I. ENP disc
- St. St disc
- Aluminium bronze disc
- Conforms to BS and ISO standards

Specifics:

Sizes: 50mm to 3000mm

Pressure: 10bar, 16bar



756/100-104 Double Eccentric Butterfly Valve PN 10/16

Stainless steel seat, IP67 gearbox, plate disc, bare shaft. Designed with tilted and fixated disc for extended service life and easy operation. The disc seal is made of AVK's drinking water approved EPDM rubber featuring an excellent compression set and thus ability to regain its original shape. The GSK approved epoxy coating and the corrosion protected shaft end zones ensure high durability. The valves are suitable for bi-directional application

Specifics:

Size: DN 200-600

Pressure: 10 + 16 + 25 Bar

Temperature: 0°C to +70°C



756/100-671 Double Eccentric Butterfly Valve PN 10/16

Integral seat, IP67 gearbox, DN 700-2800, plate disc, long, AVK double eccentric butterfly valves are designed with tilted and fixated disc for extended service life and easy operation. The disc seal is made of AVK's drinking water approved EPDM rubber featuring an excellent compression set and thus ability to regain its original shape. The high quality epoxy coating and fully encapsulated shaft/disc connection ensure high durability. The valves are suitable for bi-directional application.

Specifics:

Size: DN 200-2800

Pressure: 10 + 16 Bar

Temperature: 0°C to +70°C



LEARN MORE ABOUT VALVES BY CONTACTING THE ACADEMY

OVERVIEW

There is a wide range of valve types that have been developed to manage different fluids in a multitude of processes systems and conditions.

Some valves can start or stop flow processes whilst others throttle or regulate. Some work well in corrosive environments whilst others can withstand pressure.

The Academy aims to offer courses that assist our employees, clients, distributors, students and engineers in understanding valves and their application.

Each valve has its own advantages, disadvantages and limitations.

This course examines:

- ↔ The different valve types
- ↔ Valve end connections
- ↔ Levers, gearboxes and actuators
- ↔ Testing of valves
- ↔ Quality assurance
- ↔ Installation, operation and maintenance
- ↔ Manufacturing methods
- ↔ Reconditioning of valves

WHY SHOULD YOU ATTEND THIS COURSE?

- ↔ To expand your knowledge of the different valve types
- ↔ To understand the specifications and regulations applicable to valve products
- ↔ To get a better understanding of the manufacturing processes of valves
- ↔ To enable you to select the right valve for your application
- ↔ You can earn two CPD Points as the Valves Fundamental course is certified with SAIMEchE
- ↔ The Valve Fundamentals course is also registered with ECSA

CONTACT ROELF TO BOOK YOUR SEAT!

Tel: +27 11 908 3760
Mobile: +27 83 635 0378
E-mail: academy@avkvalves.co.za

Address: The Academy (AVK Offices)
10 Chris Street, c/o Chris and Garfield Road,
Alrode, Alberton, Gauteng, South Africa
1457

The
ACADEMY

WATER SUPPLY

CHECK VALVES



Premier Multi Door Check Valve

The Premier Multi Door Check Valve has been manufactured for DWAF and other large users for many years and has been the favoured valve for large bore installations.



Gunric Tilting Disc Check Valve Series 6146

Hydraulic Cylinder, Step Seat Design, Lever with counter weight(s), Integral or replaceable seat



Tilting Disc Check Valves

Tilting Disc Check Valves are used in large pumping stations where space is at a premium and controlled opening and closing is necessary to ensure Surge-Free operation. The Premier range of Tilting Disc Check valves is available with control accessories to ensure slow opening and fast closing with last 10% hydraulically damped if required.



Recoil Check Valves 641/21, 641/23

Non Slam Low Reverse Velocity Gun Metal Trim LG2 Epoxy Coated (250 microns) Stainless Steels Hinge Pin



Nozzle Check Valve

A range of imported and locally manufactured to solve the most arduous waterhammer applications with low pressure drop.

Specifics:

Sizes: 800mm to 2500mm

Pressure: 10bar up to 64 bar

Specifics:

Sizes: 80mm – 2500mm

Temperature: -35°C to +425°C

Specifics:

Sizes: 100mm to 1800mm

Pressure: 10bar, 16bar

Specifics:

Size: DN600-1400
Flanges to BS EN 1092-2
PN16/25

Pressure: 10bar, 16bar
Temperature: 0-70°C

Specifics:

Sizes: 100mm to 2200mm

Pressure: 20bar to 10bar, 16bar, 25bar, 40bar



Recoil Check Valves 641/11, 641/13

Non Slam Low Reverse Velocity Gun Metal Trim LG2 Epoxy Coated (250 microns) Stainless Steel Hinge Pin



IPV Check Valve (Non Return)

IPV Wafer single door check valve. Suitable for chemical and petrochemical applications. Tight shut-off, spring loaded disc, self aligning disc.



Swing Check Valves 641

Gun Metal Trim LG2. Epoxy Coated (250 microns) O-Ring Shaft Seals Stainless Steel Shaft Stainless Steel Hinge Pin

EPDM Body/Bonnet Seal



41/61 Swing check valve

Body and bonnet in ductile iron. Stem and hinge in stainless steel. Lever and weight or lever and spring.

Face to face dimension to DIN 3202-F6 / BS 5153:1974 (1992); Flanges and drilling to ISO7005-5 (EN1092-2:1997, DIN 2501). Epoxy coated internally and externally to DIN 30677.



Series 53/3X Ball check valve PN10

Ball check valve Ductile iron NBR rubber; standard flange drilling to EN1092-2 (ISO7005-2); Self cleaning function.

Specifics:

Size: Dn100 -500
Flanges to BS EN 1092-2

Pressure: 16 bar to 25 bar
Temperature: 0-70°C

Specifics:

Size: 40mm to 600mm

Temperature: -35°C to +425°C

Specifics:

Size: DN700-1000
Flanges to BS EN 1092-2
PN16/25

Pressure: 10bar, 16bar
Temperature: 0-70°C

Specifics:

Size: DN50 - DN600

Pressure: Up to 16 Bar

Temperature: 0 to +70°C

Specifics:

Size: DN50 - DN400

Temperature: 0 to +70°C

WATER SUPPLY

CHECK VALVES

WATER SUPPLY: CHECK VALVES



Double Flanged Swing Check Valve

Standard water works. Swing Check Valves to meet SABS, DIN and BS specifications.

Specifics:

Sizes: 50mm to 400mm

Pressure: 16bar



Wafer Pattern Double Door Swing Check Valve

Cast iron or stainless steel body with option of ductile iron or stainless steel doors. Also available: D.I. RL Body and Alu Bronze discs for seawater applications

Specifics:

Sizes: 50mm to 500mm

Pressure: 16bar, 25bar, 50bar, 100bar



Wafer Pattern Swing Check Valve

Carbon steel (plated) or stainless steel disc.

Specifics:

Sizes: 50mm to 400mm

Pressure: 16bar, 25bar, 50bar, 100bar, 150bar



Disc Check Valve, Wafer and Flanged

Spring loaded wafer, DI, WCB and stainless body, stainless steel disc.

Specifics:

Sizes: 50mm to 300mm

Pressure: 16bar, 25bar, 100bar, 150bar



Check Valve

Flangeless wafer type Design: Bonded rubberseat in body. Self acting rotating double disc. Design pressure 16 bar. Uni-directional tight shut-off

Specifics:

DN 50 – 600 (2" - 24")

CHECK VALVES ENSURING OPTIMUM PUMP PERFORMANCE



AVK offers a wide range of swing check valves featuring full bore and low head loss resulting in maximum utilisation of the pump capacity. The check valves can be installed in both horizontal and vertical positions and are easy to maintain.

WATER SUPPLY

CONTROL VALVES



Spherical Valves

Pressure Testing: Seat test in accordance with highest static pressure
 a) 2.5 MPa and lower – Shell test 1.5 times Design pressure
 b) Above 2.5 MPa – Shell test in accordance with $PN\ 2.5 \times 1.5 + (MPa \cdot 2.5) \times 1.25$
 c) In accordance with client specification.

Specifics:

Nominal Diameter: 500mm to 3600mm

Temperature: up to 60°C
 Operating pressures: up to 10MPa



Premier Dispersing Valve

Sleeve Valves are used as discharge regulating devices on dam outlets, pump stations, hydropower schemes and also as scour valves on large pipelines where the emptying of the pipelines has to be controlled. Operation can be with manual gearbox, electric actuator or hydraulic actuator. Custom designs to suit particular applications and installation details.

Specifics:

Sizes: 150mm to 2500mm

PN 10 - PN 60



Ring Needle Valve

The Ring Needle Valve is an inline plunger – type control valve used for open / closed or modulating applications. The Valve is available with various trims for high or low pressure drop applications, depending on the system requirements. Operation is either by manual gearbox, electric actuator or hydraulic actuator.

Specifics:

Sizes: 80mm to 1600mm

Pressure: 16bar to 64bar

Pressure Reducing Control Valve

Pressure Sustaining Control Valve

Rate of Flow Control Valve

Pressure Relief Control Valve

Pressure Reducing - Pressure Sustaining Control Valve

Booster Pump Control Valve

AVK diaphragm operated multi- function control valves for pressure reducing / pressure sustaining applications (PRV / PSV) automatically reduce a higher inlet pressure to a lower outlet pressure. The outlet pressure is kept constant, regardless of changes in flow rate or inlet pressure.

The main control valve is pilot operated, capable of a precise setting and easy adjustment of outlet pressure. With priority, the valve is also sustaining inlet pressure, defined by set-point of PSV module. Available in DN65 to DN300.

SPHERICAL VALVES OFFER INNOVATIVE DESIGN



Spherical valves are designed for the smooth flow of water with minimal flow resistance on full opening, thus reducing velocity loss and conserving energy. The innovative double sealed design offers an upstream maintenance seal and downstream service seal. The lead-free self lubricating bearing ensures strong bearing capability.

WATER SUPPLY

CONTROL VALVES



Baker Control Valve

The Baker range of self-actuated pilot operated Control Valve is the back-bone of Premier's range of Control Valves. All functions such as Pressure Reducing, Pressure Relief, Flow Control, Level Control Electronic Control and combination, of the above are available. Turn down ratio up to 4:1.

Specifics:

Sizes: 50mm to 600mm

Pressure: 6 - 50 bar



Baker Control Valve

Automatic self actuated inline Axial Flow Control Valve has features which puts it beyond the capability of standard diaphragm actuated control valves.

Specifics:

Sizes: 32mm to 1200mm

Pressure: Up to 50 Bar
Temperature: -15 - 80°C



Automatic Control Valves 853

Modular Design: Interconnecting and interchangeable parts, comprising of three major components supplied in AISI 316 stainless steel as standard, minimising spare parts. Can be altered for different applications, using specific: Single Function Modules or Multi-Function Modules.

Specifics:

Size: DN50 - DN300

Pressure: PN 10/16



Automatic Control Valve Series 859 Installation

THE BAKER CONTROL VALVE IS A 100% LOCALLY MANUFACTURED PRODUCT



Baker is a purely South African made Control Valve in the market (the valves are manufactured from locally sourced castings at Premier Valves, Alrode factory premises), and has the following key technical advantages over its competitors:

- Larger flow passages with resultant greater capacities.
- Greater cavitation resistance - 4:1 allowable pressure drop.
- "Quad" Seal which provides a bubble tight closure and long life with reduced maintenance.
- PN25 rated - standard Ductile Iron design is particularly strong/robust and long lasting.

WASTE WATER



Series 21/89
RSV gate valve with rising stem and handwheel PN16

Designed according to EN 1074 part 1 & 2; Flange drilling to EN 1092-2 (ISO 7005-2); Face to Face according to EN 558 table 2 basic series 3 (for water, sewage and neutral liquids to max 70°C).

Specifics:

Size:
DN50 - DN400

Temperature:
0 to +70°C



Series 06/35
RSV Flanged gate valves with PIN indicator and handwheel PN10/16

Designed according to EN1074 part 1 & 2 and EN1171; Face to Face according to EN 558 Table 2 Basic Series 14; Standard flange drilling to EN1092 (ISO 7005-5); Hydraulic test according to EN 1074-1 and 2/EN 12266; Epoxy coating to DIN 30677-2 and AVK Guidelines. Closing direction: RHC (for fire protection applications to Max of 70°C).

Specifics:

Size:
DN50 - DN300

Temperature:
0 to +70°C



Series 02/60
RSV Flanged gate valve PN10/16

Designed according to EN1074 part 1 & 2 and EN1171; Face to Face according to EN 558 Table 2 Basic Series 15; Standard flange drilling to EN1092 (ISO 7005-5); Hydraulic test according to EN 1074-1 and 2/EN 12266; Epoxy coating to DIN 30677-2 and AVK Guidelines. Closing direction: RHC and LHC. (for drinking water and neutral liquids to max 70°C).

Specifics:

Size:
DN400 - DN500

Temperature:
0 to +70°C



Series 43/60
RSV Flanged gate valve PN10/16

Designed according to EN1074 part 1 & 2 and EN1171; Face to Face according to SABS 664/1989.A; Standard flange drilling to EN1092 (ISO 7005-5); Hydraulic test according to SABS 664; Non-Rising Spindle; Epoxy coating to DIN 30677-2 and AVK Guidelines. Available in RHC and LHC. (for drinking water and neutral liquids to max 70°C).

Specifics:

Size:
DN50 - DN300

Temperature:
0 to +70°C



Series 01/80
Socket ended RSV gate valve PN16

Designed according to EN 1074 part 1 & 2 and EN 1171; Hydraulic test according to EN 1074-1 & 2 / EN 12266; Epoxy coating to DIN 30677-2; GSK Approved; EURO socket ends, NRS. (for drinking water and neutral liquids to max 70°C).

Specifics:

Size:
DN50 - DN400

Temperature:
0 to +70°C



Series 55/30
RSV Flanged gate valves PN10/16 (450mm - 600mm)

Designed according to DIN / EN; Face to Face according to EN 558 TABLE 2 BASIC SERIES 15; Standard flange drilling to EN1081-2; GSK guidelines; Hydraulic test according to EN 1074-1.

Specifics:

SIZE:
DN450 - DN600

Temperature:
0 to +70°C



Series 02/20
RSV Flanged gate valve PN10/16

Designed according to EN1074 part 1 & 2 and EN1171; Face to Face according to EN 558 Table 2; Basic Series 3; Standard flange drilling to EN1092 (ISO 7005-5); Hydraulic test according to EN 1074 and 2/ EN 12266; Epoxy coating to DIN 30677-2; GSK approved. (for drinking water and neutral liquids to max 70°C).

Specifics:

Size:
DN50 - DN400

Temperature:
0 to +70°C



Series 32/89
(SABS 665)
Victaulic rising gate spindle valve PN16

Designed according to SABS 664 Specification; Rising spindle ; Epoxy Coated Internally and Externally to DIN 30677-2.

Specifics:

DN50 - DN300

Temperature:
0 to +70°C



Series 32/89
(SABS 664)
Victaulic rising gate spindle valve PN16

Designed according to SABS 664 Specification; Rising spindle ; Epoxy Coated Internally and Externally to DIN 30677-2.

Specifics:

Size:
DN50 - DN300

Temperature:
0 to +70°C



Series 06/30
RSV Flanged gate valve PN10/16

Designed according to BS5150 / DN 3202 Part 1; Non-Rising Spindle; Standard Flange drilling ISO 7005-2; RHC and LHC; Face to Face to BS 5150/en10741&2; Epoxy coated according to DIN 30677-2 and GSK Guidelines; Closing direction: RHC & LHC.

Specifics:

Size:
DN50 - DN800

Temperature:
0 to +70°C

WASTE WATER



**Series 37/50
Metal seated gate
valve PN10/16**

Designed according to EN 1074 part 1 & 2; Flange drilling to EN 1092-2 (ISO 7005-2); Face to Face to EN558-1 series 3; Epoxy Coated according to DIN 30677-2 and GSK approved. (for water, sewage and neutral liquids to max 70°C).

Specifics:

Size:
DN50 - DN300

Temperature:
0 to +70°C



**756
Flanged
double eccentric
butterfly valve**

Body and disc in ductile iron. Shaft, and pins in Stainless Steel. Fusion bonded epoxy coating acc to GSK.

Specifics:

Size:
DN200 - DN2200

Pressure:
10 + 16 + 25 Bar

Temperature:
0 to +70°C



**Series 53/3X
Ball check valve
PN10**

Ball check valve Ductile iron NBR rubber; standard flange drilling to EN1092-2 (ISO7005-2); Self cleaning function.

Specifics:

Size:
DN50 - DN400

Temperature:
0 to +70°C



**Series 851/10
Double office (dual
function) air valve
with VNR - Vent
Non-Return PN25**

Air valve designed according to EN1074-4; Flanges according to EN1092-2 (ISO7005-2); Bolts: A4 Stainless steel; Epoxy coated according to DIN30677-2 and GSK approved (For portable water to max of 70°C).

Specifics:

Size:
DN50 - DN150

Temperature:
0 to +70°C



**Premier Multi Door
Check Valve**

The Premier Multi Door Check Valve has been manufactured for DWAF and other large users for many years and has been the favoured valve for large bore installations.

Specifics:

Sizes: 800mm to 2500mm

Pressure: 10bar up to 64 bar



WALL PENSTOCKS

AVK wall penstocks are square or rectangular with resilient sealing on all four sides of the slide. They are bi-directional up to and including 1200 X 1200 and in larger sizes available as bi- and uni-directional. The penstocks are with non-rising stem and closed frame, and are designed for wall mounting. AVK wall penstocks are also available with rising stem and for embedding in concrete. All penstocks in the comprehensive product range feature a low leakage rate and a reliable operation

PUMP STATIONS



Premier Wedge Gate Valve

Metal seated solid wedge rising and NRS designs with channel guides and shoes to BS 5163, DIN and SABS specs.

Specifics:

Sizes: 50mm to 2000mm

Pressure: 10 - 64bar



Premier Boving type Flanged Butterfly Valve

This valve has been favoured by the waterworks industry for many years and is still very popular today. Standard design is double offset with resilient seal on the disc and replaceable St. Si body seat. The valve is generally double flanged and manufactured to BS and ISO standards.

Specifics:

Sizes: 200mm to 3000mm

Pressure: 16bar & 25bar



756 Flanged double eccentric butterfly valve

Body and disc in ductile iron. Shaft, and pins in Stainless Steel. Fusion bonded epoxy coating acc to GSK.

Specifics:

Size: DN200-DN2800

Pressure: 10 + 16 + 25 Bar

Temperature: 0 to +70°C



Vulcanised Rubberlined Butterfly Valves EVS

Short pattern, from DN 50 with centring lugs
Construction Concentric butterfly valve with bonded vulcanised rubber linings

Specifics:

Size: DN50 - DN3000
Pressure: Up to 25 Bar
Vacuum Services
Temperature: Up to +230°C



Vulcanised Rubberlined EVFS

Short pattern
Construction Concentric butterfly valve with bonded vulcanised rubber linings

Specifics:

Sizes: DN50 - DN700

Pressure: -20°C (-4°F) to +20°C (392°F)



Series 820

Centric butterfly valve with loose liner for drinking water and neutral liquids to max. 70°C
Ductile iron with long neck for insulation. Loose liner of drinking water approved EPDM with integrated gasket faces and "saw profile" for optimum grip in body.

Specifics:

Standards:
Designed according to EN 593
Face to face according to DIN EN 558-1, series 20 (K1)
End connection to EN 1092-2
PN 6/10/16, AS2129
Tab/D/E, ASME B16.5 Cl. 150

Size: DN25-300

Temperature: max. 70°C



Ring Needle Valve

The Ring Needle Valve is an inline plunger - type control valve used for open / closed or modulating applications. The Valve is available with various trims for high or low pressure drop applications, depending on the system requirements. Operation is either by manual gearbox, electric actuator or hydraulic actuator.

Specifics:

Sizes: 80mm to 1600mm

Pressure: 16bar to 64bar



Spherical Valves

Pressure Testing: Seat test in accordance with highest static pressure
a) 2.5 MPa and lower - Shell test 1.5 times Design pressure
b) Above 2.5 MPa - Shell test in accordance with PN 2.5x1.5 + (MPa-2.5) x 1.25
c) In accordance with client specification.

Specifics:

Nominal Diameter: 500mm to 3600mm

Temperature: up to 60°C
Operating pressures: up to 10MPa



Premier Dispersing (Sleeve) Valve

Sleeve Valves are used as discharge regulating devices on dam outlets, pump stations, hydropower schemes and also as scour valves on large pipelines where the emptying of the pipelines has to be controlled. Operation can be with manual gearbox, electric actuator or hydraulic actuator. Custom designs to suit particular applications and installation details.

Specifics:

Sizes: 150mm to 2500mm

PN 10 - PN 60



Gunric Tilting Disc Check Valve Series 6146

Hydraulic Cylinder, Step Seat Design, Lever with counter weight(s), Integral or replaceable seat

Specifics:

Sizes: 80mm - 2500mm

Temperature: -35°C to +425°C

PUMP STATIONS



**Orbinox RM
Tilting disc check valve**

Solid loaded fluids pulp & paper, waste water



Nozzle Check Valve

A range of imported and locally manufactured to solve the most arduous waterhammer applications with low pressure drop.



**Recoil Check Valves
641/11, 641/13**

Non Slam
Low Reverse Velocity
Gun Metal Trim LG2
Epoxy Coated (250 microns)
Stainless Steel Hinge Pin



**41/61
Swing check valve**

Body and bonnet in ductile iron. Stem and hinge in stainless steel. Lever and weight or lever and spring.

Specifics:

Size DN40 – DN900
(1 1/2" - 36")

Pressure: Up to 40 bar depending on size

Specifics:

Sizes: 100mm to 2200mm

Pressure: 20bar to 10bar, 16bar, 25bar, 40bar

Specifics:

Size:
Dn100 -500
Flanges to BS EN 1092-2

Pressure: 16 bar to 25 bar
Temperature: 0-70°C

Specifics:

Size:
DN50 - DN600

Pressure:
Up to 16 Bar

Temperature:
0 to +70°C



AVK SERIES 41/60 SWING CHECK VALVE, PN 10/16

The full bore minimizes pressure loss and allows maximum utilisation of the pump capacity. The disc is designed with a steel insert fully vulcanized with EPDM rubber. It provides a drop tight closure and due to the light weight it requires a minimum of force to open/close.

DAMS, RESERVOIRS AND HYDROPOWER



Premier Wedge Gate Valve

Metal seated solid wedge rising and NRS designs with channel guides and shoes to BS 5163, DIN and SABS specs.

Specifics:

Sizes: 50mm to 2000mm

Pressure: 10 - 64bar



Series 06/44 Flanged gate valve PN10/16

Flanged gate valve for seawater applications to max.35°C. Designed according to EN 1074 part 1 & 2 and EN 1171; Standard Flange drilling to EN1092-2 (ISO 7005-2), PN 10/16; Hydraulic test according to EN 1074-1 and 2 / EN 12266; Seat: 1.1 x PN (in Bar), Body: 1.5 x PN (in Bar) Operation torque test.

Specifics:

Size: DN50 - DN400

Temperature: 0 to +35°C



Wedge Gate Valves 37

Aluminium Bronze Trim O-Ring Stem Seal Repack Under Pressure Cap Top Epoxy Coated (250 microns) Stainless steel Stem

WRAS Approved

Specifics:

Size: DN50-300 Flanges to BS EN 1092-2 PN16 Pressure: Temperature:0-70°C



Premier Dispensing Valve

Sleeve Valves are used as discharge regulating devices on dam outlets, pump stations, hydropower schemes and also as scour valves on large pipelines where the emptying of the pipelines has to be controlled. Operation can be with manual gearbox, electric actuator or hydraulic actuator. Custom designs to suit particular applications and installation details.

Specifics:

Sizes: 150mm to 2500mm

PN 10 - PN 60



Spherical Valves

Pressure Testing: Seat test in accordance with highest static pressure a) 2.5 MPa and lower - Shell test 1.5 times Design pressure b) Above 2.5 MPa - Shell test in accordance with PN 2.5x1.5 + (MPa-2.5) x 1.25 c) in accordance with client specification.

Specifics:

Nominal Diameter: 500mm to 3600mm

Temperature: up to 60°C Operating pressures: up to 10MPa



Premier Boving type Flanged Butterfly Valve

This valve has been favoured by the waterworks industry for many years and is still very popular today. Standard design is double offset with resilient seal on the disc and replaceable St. St body seat. The valve is generally double flanged and manufactured to BS and ISO standards.

Specifics:

Sizes: 200mm to 3000mm

Pressure: 16bar & 25bar



Flanged double eccentric butterfly valve

Body and disc in ductile iron. Shaft, and pins in Stainless Steel. Fusion bonded epoxy coating acc to GSK.

Specifics:

Size: DN200 - DN2200

Pressure: 10 + 16 + 25 Bar

Temperature: 0 to +70°C



Varix U-Pattern Butterfly Valve

Varix U-Pattern available with replaceable bonded liner similar to wafer pattern.

Specifics:

Sizes: 150mm to 1200mm

Pressure: 10bar 16bar



Rubberlined EVFS

Short pattern

Construction Concentric butterfly valve with bonded vulcanised rubber linings

Specifics:

Sizes: DN50 - DN700

Pressure: -20°C (-4°F) to +20°C(392°F)



Series 820

Centric butterfly valve with loose liner for drinking water and neutral liquids to max. 70°C Ductile iron with long neck for insulation. Loose liner of drinking water approved EPDM with integrated gasket faces and "saw profile" for optimum grip in body.

Specifics:

Standards: Designed according to EN 593 Face to face according to DIN/EN 558-1, series 20 (K1) End connection to EN1092-2 PN 8/10/16, AS2129 TabD/E ASMEB16.5 Cl. 150

Size: DN25-300

Temperature: max. 70°C

DAMS, RESERVOIRS AND HYDROPOWER



**Gunric
Tilting Disc Check
Valve Series 6146**

Hydraulic Cylinder, Step Seat Design, Lever with counter weight(s), Integral or replaceable seat.

Specifics:

Sizes:
80mm – 2500mm

Temperature:
-35°C to +425°C



**Nozzle Check
Valve**

A range of imported and locally manufactured to solve the most arduous waterhammer applications with low pressure drop.

Specifics:

Sizes: 100mm to 2200mm

Pressure: 20bar to 10bar,
16bar, 25bar, 40bar



Swing check valve

Body and bonnet in ductile iron. Stem and hinge in stainless steel. Lever and weight or lever and spring.

Specifics:

Size:
DN50 – DN600

Pressure:
Up to 16 Bar

Temperature:
0 to +70°C



**Check Valve
Double Door**

Flangeless wafer type Design. Bonded rubbenseat in body. Self acting rotating double disc. Design pressure 16 bar. Uni-directional tight shut-off

Specifics:

DN 50 – 600

Pressure 16 bar +40°C (-40°F)
to + 20°C(392°F)



**Recoil Check Valves
641/11, 641/13**

Non Slam Low Reverse Velocity Gun Metal Trim LG2 Epoxy Coated (250 microns) Stainless Steel Hinge Pin

Specifics:

Size:
Dn100 -500
Flanges to BS EN 1092-2

Pressure: 16 bar to 25 bar
Temperature:0-70°C



**Ring Needle
Valve**

The Ring Needle Valve is an inline plunger – type control valve used for open / closed or modulating applications. The Valve is available with various trims for high or low pressure drop applications, depending on the system requirements. Operation is either by manual gearbox, electric actuator or hydraulic actuator.

Specifics:

Sizes: 80mm to 1600mm

Pressure: 16bar to 64bar

EXPECT GLOBAL LEADERSHIP & LOCAL COMMITMENT

Together, Premier Valves, Orbinox Valves and Glenfield Limited form a combined wealth of experience, expertise and resource to globally develop the AVK Dams, Reservoirs and Hydro Power Sector.

Our common product portfolio comprises of a large and comprehensive range of valves, including bonneted gate valves, radial and roller gates, discharge valves, large diameter knife gates valves, butterfly valves, check and recoil valves, gate valves, needle valves, spherical and boving valves for the Dams, Reservoirs & Hydro Power segments.

For more information visit www.avkvalves.co.za and download our Dams, Reservoirs and Hydropower brochure.



FIRE PROTECTION



Series 45/56 Gate Valves, flanged, OS&Y

Ductile Iron
UL/FM

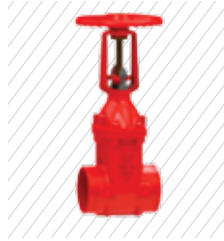

Series 45/16 Gate Valves, grooved IPS, OS&Y

Ductile Iron
UL/FM



Series 45/59 Gate Valves, flanged for post indicator, 250 PSI

Ductile Iron
UL/FM



Series 45/59 Gate Valves, flanged, NRS. 250 PSI

Ductile Iron
UL/FM



Series 815, Butterfly valves, grooved

FM

Specifics:

x:
0 = EN 1092, PN 10
1 = EN 1092, PN 16
2 = ANSI B16.1, CL 125

Specifics:

Specifics:

x:
0 = EN 1092, PN 10
1 = EN 1092, PN 16
2 = ANSI B16.1, CL 125

Specifics:

x:
0 = EN 1092, PN 10
1 = EN 1092, PN 16
2 = ANSI B16.1, CL 125

Specifics:

x:
0 = EN 1092, PN 10
1 = EN 1092, PN 16
2 = ANSI B16.1, CL 125



Series 75, Butterfly Valves, Wafer

FM

Note: Weight without actuator



Series 34, Post indicator for Gate Valve, telescopic type

Features:
Operating - NRS Wrench operated
Mounting - Flanged Plate

Materials:

Body - Ductile Iron
Rod - Steel
Barrel - Ductile Iron
UL/FM

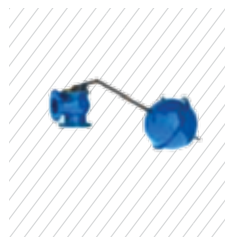

Series 845/00-001

Equilibrium Right Angled Ductile Iron Ball Float valve
Lever: Hot dipped galvanised
Coating: Internal and external blue fusion bonded epoxy 250 microns

Options: Large sizes, delayed action type, flanged drillings

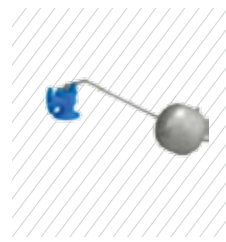

Series 845/00-002

Equilibrium Right Angled Ductile Iron Ball Float valve with stainless steel lever and float.

Lever: Stainless steel
Coating: Internal and external blue fusion bonded epoxy 250 microns



Series 24/70-001 Wet Barrel Hydrant

with 1x2½" + 1x4½" outlets

UL/FM approved
EPDM rubber
AWWA C550
Closing direction: CTC

FIRE PROTECTION

FIRE PROTECTION



**Series 27/30
Dry Barrel Hydrant**

To AWWA C502
UL Listed
2 Hose Nozzles and
1 Pumper Nozzle
Extended Alpine Upper
Barrel

Standard bases available:
6" FL
6" MJ
6" PO
4" FL or 4" MJ
Modern style
Ductile Iron



**Series 27/00
Dry Barrel Hydrant**

To AWWA C502
UL Listed
FM Approved
2 Hose Nozzles and 1
Pumper Nozzle
Standard bases available:
6" FL
6" MJ
6" PO
4" FL or 4" MJ
Modern style
Ductile Iron



**Series 24/90-001
Wet Barrel Hydrant**

with 2x2½" + 1x4½" outlets
to AWWA C 503
UL/FM approved
EPDM rubber
AWWA C550
Closing direction: CTC



**Series 24/72
Wet Barrel Hydrant**

To AWWA C 503
Threaded nozzles
UL/FM approved
One pumper and one hose
Ductile Iron



**Series 29/388 Fire
Hydrant BS 750
Type 2**

Stainless Steel London
Round Thread outlet Epoxy
coated according to WIS
4-52-01 class B
WRAS approved
Universally drilled flange to
BS EN 1092:1997
DN80

Options on outlets:
Gunmetal, Belfast, London
'V' Thread, Bayonet (Dublin),
Norwegian, Morris



**TP Series A53 Fe-
male to Male Hose
Connection Gate
Valve**

Brass
UL/FM



**TP Series A53G Male
to Female Swivel
Gate Valve**

Brass
UL/FM



**TP Series A85 Dou-
ble Female Straight
Globe Hose Valve**

Brass
Threaded female
UL/FM

**WHEN EVERY SECOND
COUNTS COUNT ON AVK VALVES
AND HYDRANTS**

FIRE PROTECTION



**Series YS-2104A
Globe Valves
straight**

Brass - threaded NPT
female
UL listed



**TP Series A55 Dou-
ble Female Angle
Hose Valve**

Brass
UL/FM



**TP Series A56 Fe-
male to Male Hose
Connection Angle
Hose Valve**

Brass
UL/FM



**TP Series YS-2106A
Globe Valves angle,
for hose**

Brass
Threaded NPT female
UL listed/FM



**Series VCF01 Check
Valve Swing Type -
Flanged**

Ductile Iron

Features:
Type - spring actuated
Connection - Flanged

Materials:
Body - Ductile GGG 50
Disc - Stainless Steel
Seat - Bronze
Seal - EPDM rubber
UL Listed. FM pending



For more information on our Fire Protection Range
visit www.avkvalves.co.za

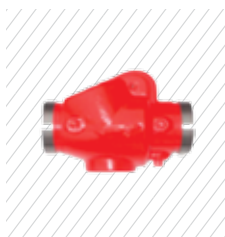

**Series VCG01 Check
Valve Swing Type
Grooved End**

Ductile Iron

Features:
Type - spring actuated
Connection - Flanged

Materials:
Body - Ductile Iron
Disc - Stainless Steel
Seal - EPDM rubber
UL/FM



**Series VCG02 Riser
(Shotgun) Check
Valve Swing Type -
Grooved End**

Ductile Iron

Features:
Working Pressure - 350 PSI
/ 24 bar
Type - spring actuated
Connection - Grooved

Materials:
Body - Ductile Iron
Disc - Stainless steel
Seat - Bronze
Seal - PDM rubber
UL/FM

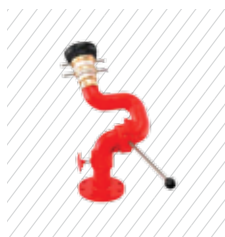

Fire Monitor

Available in 2" NPT or 2"
BSP threaded inlet and
optional flange
Compatible with self-educ-
ting foam monitor nozzles for
various application
Flow rate is 199 (LPM)
Inlet size is 2" to 3"
Made from Brass material
Travel is 140° vertical an
360° rotation



COUPLINGS, FLANGE ADAPTORS, DISMANTLING JOINTS AND REPAIR CLAMPS



DISMANTLING JOINT AND RESTRAINED FLANGED ADAPTOR

Dismantling Joints & Restrained Flange Adaptors are designed to provide greater versatility for the designer at the planning stage and the contractor at the installation stage of flanged pipe work systems. Dismantling Joints allow for simpler valve and pump maintenance in chambers.



POLYGRIP

The PolyGrip Range was designed as a simple, high performance end load restraint mechanical method of joining PVC and HDPE pipe. Designed to support and grip the pipe, preventing pipe collapse and pipe end pullout. The coupling is suitable for working pressure up to 16 bar (1600 kPa).



DEDICATED COUPLINGS FOR PVC PIPE

DediFit Couplings are designed specifically for quick and simple installation on PVC pipe. The limited & dedicated operating range ensures the couplings are tight with only several turns of the nut. DediFit Couplings are supplied in Red Oxide Fusion Bonded Epoxy corrosion protection. Sizes available include 63mm, 90mm, 110mm, 160mm, 200mm, 250mm, 315mm. All couplings are suitable for a 16 Bar Working Pressure.



DEDICATED LARGE DIAMETER COUPLINGS

Large Diameter Couplings & Adaptor Products are designed to allow several degrees of pipeline angular deflection. Ideal for accommodating misaligned pipes. Simplifying the task of the design engineer & contractor. This comprehensive range is available from DN700 - 3000mm. Stepped couplings join pipes of different external diameters and flange adaptors can be supplied with flanges drilled to any national or international standard, or to a customers own detailed specification with pressure ratings up to 64bar (6400kPa).



UNIVERSAL WIDE RANGE COUPLINGS AND ADAPTORS

For joining plain ended pipes of similar or dissimilar materials, UNIFIT Universal Couplings have wide sealing tolerances ensuring all popular pipe materials can be connected. From DN40 - 600mm. Larger diameter wide range couplings can be manufactured. UNIFIT designed specifically for the connection of GRP & HDPE pipe. Barrel lengths are specified to cater for HDPE expansion & contraction upon installation. They can be used to span large gaps between pipe ends.



ULTRA CLAMP

The Ultra Clamp Series is a comprehensive range of stainless steel pipe repair clamps for rigid pipe materials. They should not be used to join pipes. Ultra Clamps are available in various clamp lengths (up to 1200mm wide) and they are suitable for virtually any pipe material. Ultra Clamp products from DN40mm and greater are supplied as full circumferential repair clamps, complete with a stainless steel armour plate vulcanized into the rubber seal at the time of moulding. Ultra Clamps are constructed from 100% stainless steel and therefore offer a permanent repair for many types of pipe damage such as cracks, holes and corrosion pitting. Special sizes and widths, and high speed manufacturing for urgent breakdowns are available on request.

HOW TO FIND OUR FULL DOCUMENTATION



TWO PATHS TO OUR DOCUMENTATION

We have done our utmost to make it easy to find specific product documentation on www.avkvalves.eu.

Choose your area of interest in the upper menu. e.g. "fire protection", and get an overview of our products within this area (to the left).

You can also go directly to the "product finder", and pick your choice in the drop down lists. You can choose to fill in all the blanks to find a specific product, or just fill in a few to get an overview of the range. Or you can choose the quick path, "product series", using the product series numbers stated in this brochure. In the free search field you can state other details such as specific item number.

PRODUCT FINDER

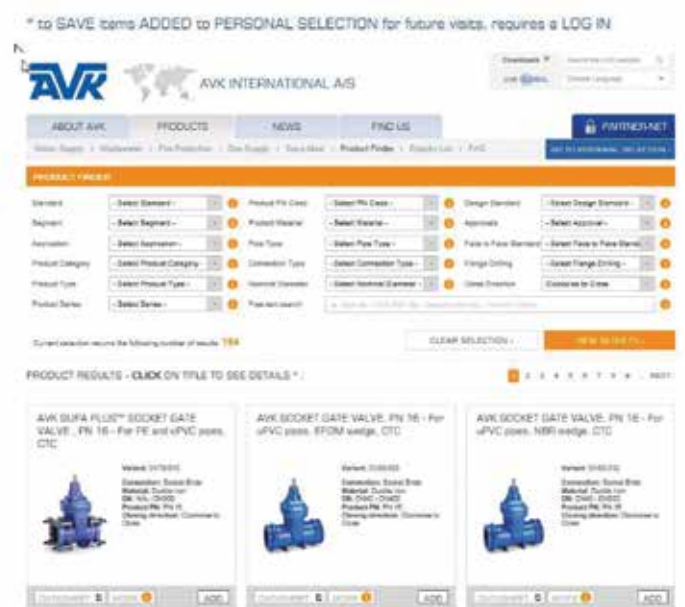
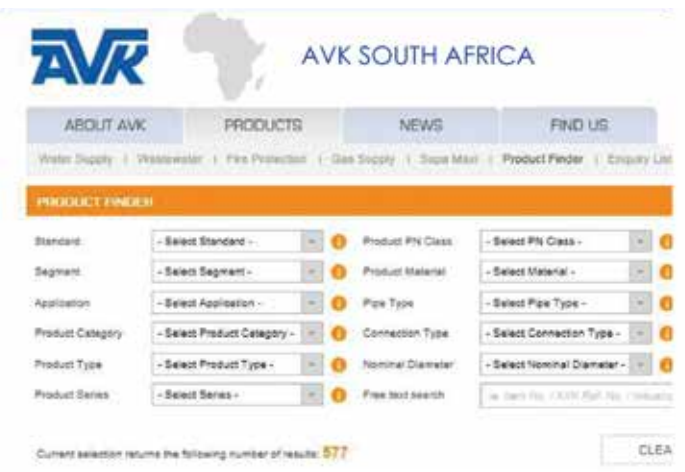

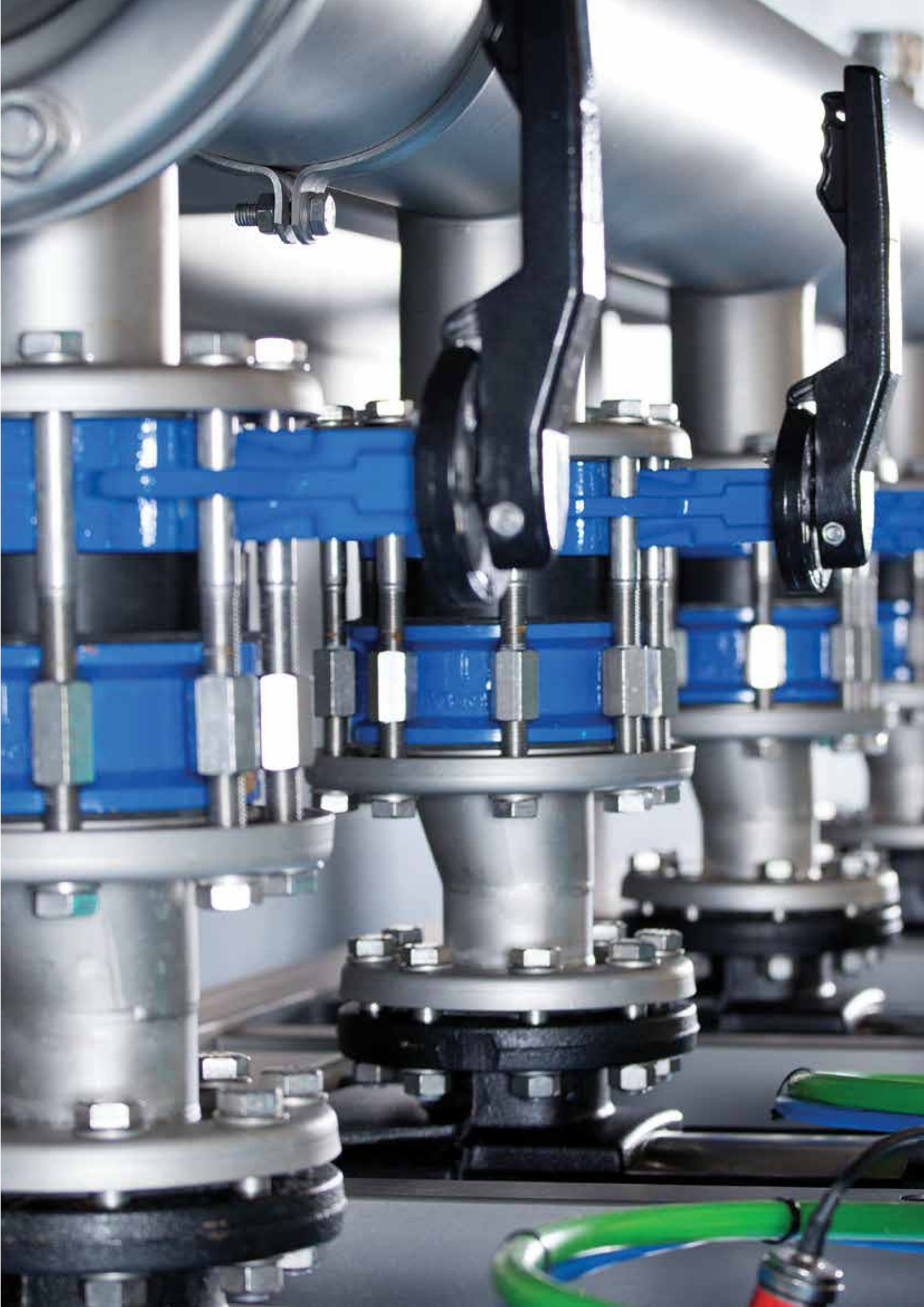



**PREMIER
VALVES**



IA[®]
InterApp

IPV
Industrial & Petroleum Valves

WW  EuroValve

AVR



 **ORBINOX**
VALVE TECHNOLOGY. MORE THAN 100 COUNTRIES

 **BCV**
BAKER CONTROL VALVE

Glenfield
Dams, reservoirs & hydra solutions

Members of the **AVR** group

**AVK SOUTHERN AFRICA (PTY) Ltd
(JOHANNESBURG)**
10 Chris Street
C/o Chris and Garfield Road
Alrode, Alberton, Johannesburg, 1457
(T) +27 12 653 8313
(F) +27 12 653 5580

**AVK SOUTHERN AFRICA (PTY) Ltd
(CAPE TOWN)**
6 Monaco Road
Killarney Gardens,
Cape Town, 7441
(T) +27 21 981 4414
(F) +27 21 981 4493

